

DENIA STOVES KYOTO

La estufa Denia Stoves Kyoto combina estilo y eficiencia con doble combustión y cristal limpio. Su diseño elegante y funcional es ideal para todo hogar.



[Ver más información online](#)

MEDIDAS







DIMENSIONES A x A x F	1147x514x460 mm
PESO BRUTO/NETO	133/127 kg
DIMENSIONES PUERTA	310x565 mm
SALIDA DE HUMOS	Ø 150-153 mm Vertical
ENTRADA DE AIRE EXTERIOR	Ø 80 mm

CARACTERÍSTICAS

PARRILLA DE HIERRO FUNDIDO	
VISION PANORÁMICA	
CUERPO EN CHAPA	5 mm
POTENCIA CALORÍFICA	8 KW
RENDIMIENTO	78 %
EMISIÓN DE CO	0,10%
PINTURA ANTI-CALÓRICA RESISTENTE	800°C
CRISTAL VITROCERÁMICO RESISTENCIA	750°C

PLUS PRODUCTO

ECODESIGN

-  TOMA DE AIRE EXTERIOR
-  HOGAR REVESTIDO EN VERMICULITA
-  TRONCOS HASTA 50 CM
-  VOLUMEN DE CALEFACCIÓN 250 m³
-  DOBLE COMBUSTIÓN
-  SISTEMA CRISTAL LIMPIO

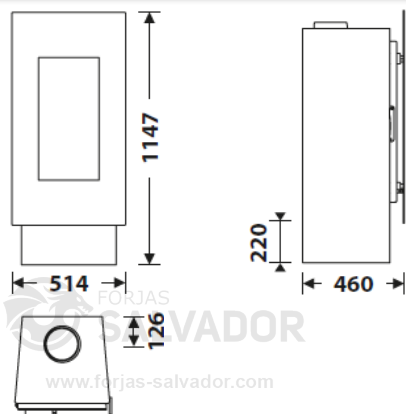

EAN 8426964116205
REF. 11620



BlmSchV2



KYOTO EcoDesign



KYOTO ES

